

# PRODUCT DATA SHEET

## PRODUCT DESCRIPTION

The Eurotec Flex-Stone-Clip and Stone-Edge-Clip are **specially designed** for the **Eurotec EVO and EVO Slim** aluminium system profile, and for the **HKP terrace support system**. It can also be used in combination with Eurotec adjustable feet. When combined with the Eurotec adjustable feet, it is possible to create a so far **unique, professional elevation of the substructure** for all types of concrete and **natural stone slabs**.

## FLEX-STONE-CLIP ADVANTAGES

- For clipping onto the aluminium system profiles in the installation location
- The new Flex Stone Clip is flexible enough to compensate for production-related tolerances of up to 2 mm in stone slabs.
- The joint width is 4 mm

## STONE-EDGE-CLIP ADVANTAGES

- For clipping onto the edge of the aluminium system profiles
- To prevent the stone slabs from slipping in the area around the edges, it is necessary to fix the clips with a profile drilling screw of 4.2 × 35 mm.
- The joint width is 4 mm

## MATERIAL

- Polypropylene

## IMAGES OF APPLICATIONS



Flex-Stone-Clip with impact sound insulation plate.



Stone-Edge-Clip with impact sound insulation plate.

## FLEX-STONE-CLIP AND STONE-EDGE-CLIP



Flex-Stone-Clip



Stone-Edge-Clip



Aluminium profile drilling screw

Compatible  
with



Impact sound insulation plate Ø 90 mm

# PRODUCT DATA SHEET

## FLEX-STONE-CLIP AND STONE-EDGE-CLIP

### PRODUCT TABLE

Art. no.	Joint strip dimensions [mm] <sup>1)</sup>	Drive	PU
Flex-Stone-Clip			
975602	8 × 14 × 4		200*
Stone-Edge-Clip			
975603	8 × 14 × 4		50**
Aluminium profile drilling screw			
645026	4.2 × 35	TX15 •	100

<sup>1)</sup>Height × length × width

\* We recommend using special aluminium profile screws (645026) for attachment. They are not part of the scope of the delivery.

\*\* Delivery including one screw per clip

### DRAWINGS

- Flex-Stone-Clip

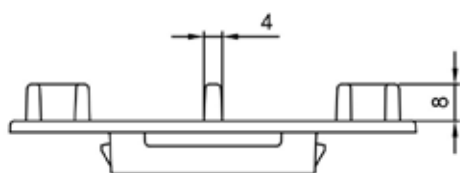

Side view

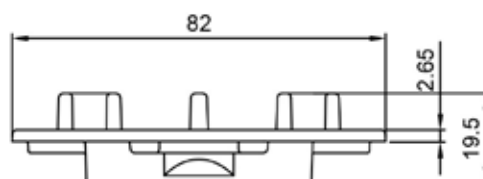

Side view

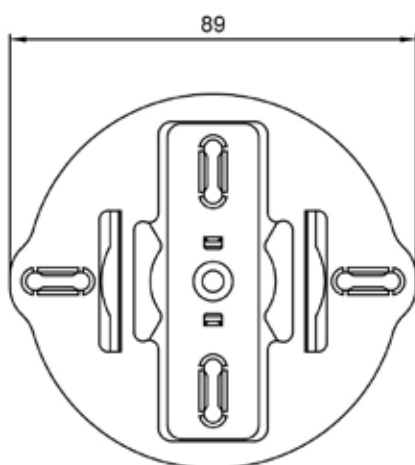

Top view

# PRODUCT DATA SHEET

## FLEX-STONE-CLIP AND STONE-EDGE-CLIP

- Stone-Edge-Clip

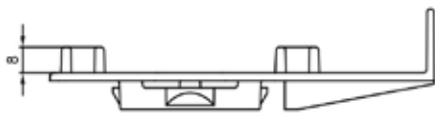

Side view

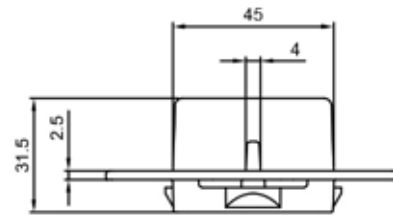

Front view

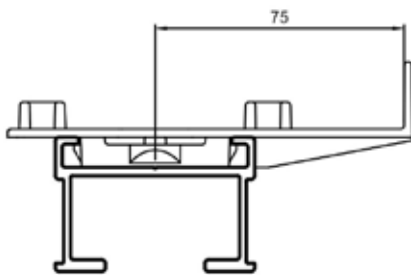

Front view

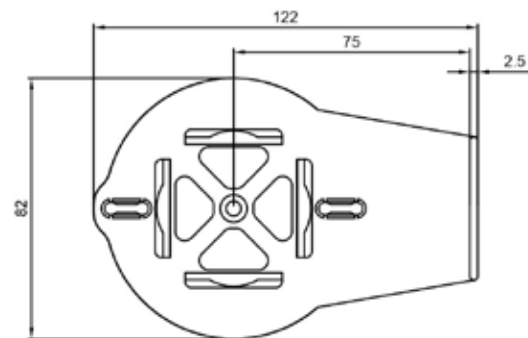

Top view

If you are not familiar with how to use this product, especially with its intended use, get in touch with our Application Engineering Department ([technik@eurotec.team](mailto:technik@eurotec.team)).